

# MAC 4275

FM/AM RECEIVER

**McIntosh<sup>®</sup>**

OWNERS MANUAL



# IMPORTANT SAFETY INSTRUCTIONS

**THESE INSTRUCTIONS ARE TO PROTECT YOU AND THE McINTOSH INSTRUMENT. BE SURE TO FAMILIARIZE YOURSELF WITH THEM.**

1. Read all instructions - Read the safety and operating instructions before operating the instrument.
2. Retain Instructions - Retain the safety and operating instructions for future reference.
3. Heed warnings - Adhere to warnings and operating instructions.
4. Follow Instructions - Follow all operating and use instructions.
5. Power Sources - Connect the power supply only to the type described in the operating instructions or as marked on the unit.
6. Power-Cord Protection - Route power-supply cords so that they are not likely to be walked on or pinched by items placed upon or against them, paying particular attention to cords at plugs, convenience receptacles, and the point where they exit from the instrument.
7. Ventilation - Locate the instrument for proper ventilation. For example, the instrument should not be placed on a bed, sofa, rug, or similar surface that may block ventilation openings; or, placed in a built-in installation, such as a bookcase or cabinet, that may impede the flow of air through the ventilation openings.
8. Heat - Locate the instrument away from heat sources such as radiators, heat registers, stoves, or other appliance (including amplifiers) that produce heat.
9. Wall or Cabinet Mounting - Mount the instrument in a wall or cabinet only as described in the owners manual.
10. Water and Moisture - Do not use the instrument in a wall or cabinet only as described in the owners manual.
11. Cleaning - Clean the instrument by dusting with a dry cloth. Clean the panel with a cloth moistened with a window cleaner.
12. Object and Liquid Entry - Do not permit objects to fall and liquids to spill into the instrument through enclosure openings.

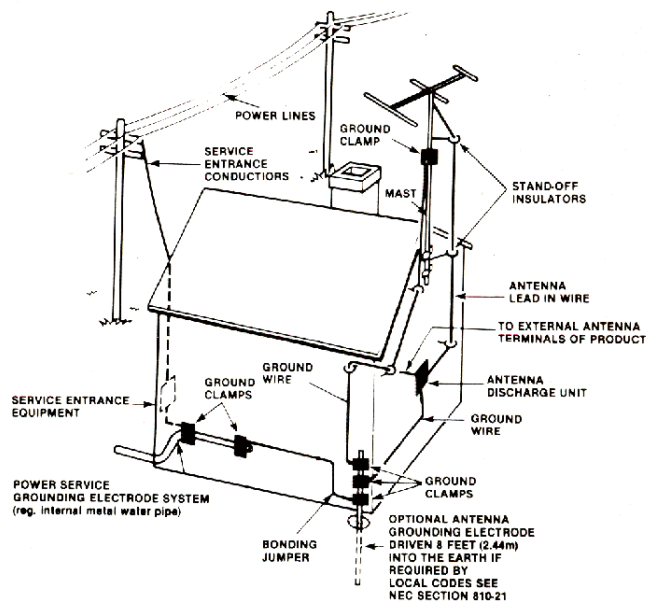

13. Power Lines - Locate any outdoor antenna away from power lines.

14. Outdoor Antenna Grounding - If an outdoor antenna is connected to the antenna terminal, be sure the antenna system is grounded to provide some protection against voltage surges and built up static charge.

IN the U.S.A., section 810 of the National Electrical Code, ANSI/NFPA No. 70-1984, provides information on the proper ground for the mast and supporting structure, ground for the lead-in wire to an antenna discharge unit, and size of ground conductors, location of antenna-discharge unit, connection to grounding electrodes, and requirements for the grounding electrode.

For ground wire:

- a) Use No. 10 AWG (5.3 mm<sup>2</sup>) copper, No. 8 AWG (8.4 mm<sup>2</sup>) aluminum, No. 17 AWG (1.0 mm<sup>2</sup>) copper-clad steel, bronze wire, or larger as ground wire.
- b) Secure antenna lead-in and ground wires to house with stand-off insulators spaced from 4 feet (1.22 meters) to 6 feet (1.83 meters) apart.
- c) Mount antenna discharge unit as closely as possible to where lead-in enters house.
- d) Use jumper wire not smaller than No. 6 AWG (13.3 mm<sup>2</sup>) copper or equivalent when separate antenna grounding electrode is used.



15. Nonuse Periods - Unplug the power cord from the AC power outlet when left unused for a long period of time.
16. Damage Requiring Service - **Service must be performed by qualified service personnel when:**
- A. The power supply cord or the plug has been damaged; or
  - B. Objects have fallen, or liquid has been spilled into the instrument; or
  - C. The instrument has been exposed to rain; or
  - D. The instrument does not appear to operate normally or exhibits a marked change in performance; or
  - E. The instrument has been dropped, or the enclosure damaged.
17. Servicing - Do not attempt to service beyond that described in the operating instructions. All other service should be referred to qualified service personnel.

18. Grounding or Polarization - Do not defeat the inherent design features of the polarized plug. Non-polarized line cord adaptors will defeat the safety provided by the polarized AC plug.
19. **CAUTION: TO PREVENT ELECTRICAL SHOCK DO NOT USE THIS (POLARIZED) PLUG WITH AN EXTENSION CORD, RECEPTACLE OR OTHER OUTLET UNLESS THE BLADES CAN BE FULLY INSERTED TO PREVENT BLADE EXPOSURE.**

**ATTENTION: POUR PREVENIR LES CHOCS ELECTRIQUES PAS UTILISER CETTE FICHE POLARISEE AVEC UN PROLONGATEUR, UNE PRISE DE COURANT OU UNE AUTRE SORTIE DE COURANT, SAUF SI LES LAMES PEUVENT ETRE INSEREES A FOND SANS EN LAISSER AUCUNE PARTIE A DECOUVERT.**



The lightning flash with arrowhead, within an equilateral triangle, is intended to alert the user to the presence of uninsulated "dangerous voltage" within the product's enclosure that may be of sufficient magnitude to constitute a risk of electric shock to persons.



**CAUTION: TO PREVENT THE RISK OF ELECTRIC SHOCK, DO NOT REMOVE COVER (OR BACK). NO USER-SERVICABLE PARTS INSIDE. REFER SERVICING TO QUALIFIED PERSONNEL.**



The exclamation point within an equilateral triangle is intended to alert the user to the presence of important operating and maintenance (servicing) instructions in the literature accompanying the appliance.

The serial number, purchase date, and McIntosh Laboratory Service Contract number are important to you for possible insurance claim or future service. Record this information here.

Serial Number

Purchase Date

Service Contract Number

Upon application, McIntosh Laboratory provides a Service Contract to the original purchaser. Your McIntosh Authorized Service Agency can expedite repairs when you provide the Service Contract with the instrument for repair.



# Contents

INTRODUCTION	4
HOW TO CONNECT	5, 6, 7, 8
FRONT PANEL	9, 10, 11
PERFORMANCE LIMITS	12, 13
PERFORMANCE CHARTS	14, 15, 16
TECHNICAL DESCRIPTION	17, 18, 19
BLOCK DIAGRAM	20, 21, 22, 23

Your MAC 4275 FM/AM Receiver will give you many years of satisfactory performance. If you have any questions, please contact,

## CUSTOMER SERVICE

McIntosh Laboratory Inc.  
2 Chambers Street  
Binghamton, New York 13903-9990  
Phone: 607-723-3512

**Take Advantage of 3 Years of  
Contract Service . . .  
Fill in the Application NOW.**

---

## McINTOSH THREE YEAR SERVICE CONTRACT

---

An application for A THREE YEAR SERVICE CONTRACT is included with this manual.

The terms of the contract are:

1. If the instrument covered by this contract becomes defective, McIntosh will provide all parts, materials, and labor needed to return the measured performance of the instrument to the original performance limits free of any charge. The service contract does not cover any shipping costs to and from the authorized service agency or the factory.
2. Any McIntosh authorized service agency will repair all McIntosh instruments at normal service rates. To receive the free service under the terms of the service contract, the service contract certificate must accompany the instrument when taken to the service agency.
3. Always have service done by a McIntosh authorized service agency. If the instrument is modified or damaged as a result of unauthorized repair the service contract will be cancelled. Damage by improper use or mishandling is not covered by the service contract.
4. The service contract is issued to you as the original purchaser. To protect you from misrepresentation this contract cannot be transferred to a second owner.
5. Units in operation outside the United States and Canada are not covered by the McIntosh Factory Service Contract, irrespective of the place of purchase. Nor are units acquired outside the USA and Canada, the purchasers of which should consult with their dealer to ascertain what, if any, service contract or warranty may be available locally

The McIntosh MAC 4275 is a high quality FM/AM Receiver whose design has been governed by insistence on high performance with long life, great flexibility and sensitivity.

You will derive the greatest enjoyment and the most satisfaction from your MAC 4275 when you understand its operations and functions. Your time invested now in reading this manual, will return added value and you will get the best results from the operation of your receiver.

Some of the features that set the MAC 4275 apart from the ordinary are:

This "state-of-the-art" FM/AM tuner displays the station frequencies digitally. Stations are selected easily by the preset station pushbuttons or tuned with the manual tuning knob, or you can scan up or down either broadcast band. When the stations assigned frequency is displayed, tuning is locked and held to the precise center of the broadcast channel. When the pushbutton presets have been programmed, the electronic memory will store and retain your 5 favorite stations, both on FM and AM, for instantaneous recall at the press of a button.

The information in the tuning memory is retained for a week even though the receiver should become disconnected from the AC power line.

A unique Phase Locked Loop Multiplex decoder delivers STEREO FM with lower distortion, lower noise, and better separation.

You can tape record high quality FM broadcasts without the interference that stereo transmission can cause. Carefully designed suppression circuits eliminate the potential for stereo carrier noise when making "off the air" tape recordings.

Separate listen and record facilities, introduced and perfected by McIntosh, permit tape recording one program while listening to a second program. Separate input selectors, electrically isolated from each other, provide non-interference operation in both listen and record.

You can record on 2 tape recorders from any source and you can easily copy from one tape recorder to another.

Three separate tone shaping controls provide musical spectra tone shaping. Each control adjusts selected frequency bands to satisfy your personal preference or the demands of the program material. At the detent in the center of the rotation of each control the equalizer circuits are disconnected, completely removed from the operating circuits.

Special low frequency bass augmentation is available to assist loudspeakers lacking in bass. The curve is centered to assist the bass and prevent stressing a loudspeaker beyond its operating characteristics.

Technological leadership is shown in the full power McIntosh amplifier which will deliver its maximum power output to one or two pairs of loudspeakers. The quality of the sound reproduction and the quality of your speakers are protected by the patented\* McIntosh Power Guard.

The Power Guard waveform comparison circuit detects waveform differences between the input and the output signal. A sampling of the program material at the output of the amplifier is constantly compared with the program material at the amplifier input. Should the differences reach 0.5%, Power Guard goes to work. In only a fraction of a millisecond Power Guard dynamically reduces input level to prevent amplifier overload yet permits the amplifier to deliver its absolute maximum power output without extra distortion. The operation of the Power Guard circuit is absolutely silent. There is not even "soft" clipping. There is simply no clipping!

The (patented\*) Sentry Monitoring circuit constantly monitors the output signal. At signal levels up to rated output this circuit has no effect. If the power output exceeds design maximum, or in the event of a short circuit or severe mismatch, the Sentry Monitoring circuit protects the output transistors from failure.

A rear panel connector provides adaptability to complete remote control with the addition of the McIntosh infrared REMOTE CONTROL system.

All in all, your selection of the McIntosh MAC 4275 FM/AM Receiver will be reinforced by your day-to-day use of this superb instrument. Good listening.

**\*McIntosh research, engineering and design has developed circuits covered by these U.S. Patents: 3,965,295; 4,048,573; 3,526,847; and 3,526,846.**

---

## 4 INTRODUCTION



The MAC 4275 can be used on a shelf or table top. In any case provide adequate ventilation. Do not cover the top ventilation grid in any way. The trouble-free life of any electronic instrument is greatly extended by providing sufficient ventilation to prevent the build-up of heat that causes deterioration of component parts. Allow enough clearance so cool air can enter at the bottom of the receiver and be vented from the top. To allow reasonable ventilation, the feet on the bottom of the receiver must be left in place. Should temperatures increase due to restricted ventilation or speaker mismatch, an automatic temperature sensing device turns the speakers off. The thermal sensor operates automatically so the speakers will turn on again when the temperature has returned to normal limits. This additional feature assures complete reliability under the most extreme operating conditions.

Use shielded cables to interconnect any audio signal source with the receiver. To minimize the possibility of hum or noise, the shielded cables should be of parallel construction or loosely twisted together, located away from the speaker connecting cables and AC power cords. Be certain to use good quality shielded cables for all interconnections. Your dealer can best advise you on the kind, length and quality of cable that will best suit your installation.

The appropriate length and size of the loudspeaker cable for you installation will help to preserve the high quality of sound for which the loudspeakers have been designed. If undersize wire is used, resistance is added to the amplifier/loudspeakers combination which adversely affects their performance. Added resistance reduces the damping factor, modifies the frequency response and reduces the power output. The cables to and from the speaker should be of parallel construction or be loosely twisted together. Your dealer's advice will serve you best for your installation.

The chart shows the minimum wire size between the amplifier and the loudspeakers.

#### MAXIMUM AMPLIFIER TO SPEAKER CABLE LENGTHS

For 4 Ohm Load		For 8 Ohm Load		Wire Gauge
Feet	Meters	Feet	Meters	
15	6	30	9	18
25	8	50	15	16
40	12	80	24	14
60	18	120	37	12
100	30	200	60	10

The back cover folds out to show photographs of the front and rear panels of the MAC 4275. Fold it out to assist you in locating the connectors. The numbers refer to the numbered paragraphs that follow.

#### 1. SPEAKERS 1, SPEAKERS 2

Rear panel barrier terminals are provided to connect two pairs of stereo speakers. The front panel pushbuttons turn the speaker pairs on or off.

Connect the leads from the left main (1) loudspeaker to the SPEAKERS L 1 and Common screw terminals.

Connect the leads from the right main loudspeaker to the SPEAKERS R 1 and Common screw terminals. Connect a second pair of speakers to the SPEAKERS 2 in a similar manner. To maintain frequency response, power output and damping characteristics, each speaker requires a separate cable between the receiver and the loudspeaker.

#### 2. PHONO

When the turntable is equipped with a moving magnet cartridge, connect the cable from the turntable left channel to the left PHONO MM input. Connect the cable from the turntable right channel to the right PHONO MM input. Adjust the CARTRIDGE TYPE switch to the MM position.

When the turntable is equipped with a moving coil cartridge, connect the cable from the turntable left channel to the left PHONO MC input and the cable from the right channel to the right PHONO MC input. Adjust the CARTRIDGE TYPE switch to the MC position. If the turntable has a separate ground lead, connect it to the post marked ground (GND).

#### 3. GROUND

A ground (GND) post is provided to connect the grounds from record changers, tape decks, etc. To prevent hum pickup, the left and right program cables and the ground wire from that source should be wound or loosely twisted together. Make sure the ground wire does not make any contact to the shields of the left and right program cables as they run between the source and the input jacks.

#### 4. AUX

Audio from any high level source is connected to AUX 1 INPUTS. Connect a cable from the left channel audio output of a TV monitor or other high level source, to the L AUX INPUT jack. Connect a cable from the right channel audio output to the R AUX INPUT jack.



## 5. CD

Connect the cable from the Compact Disc (CD) player left channel output to the left CD INPUT. Connect the cable from the CD player right channel output to the right CD INPUT.

## 6. TAPE 1, TAPE 2

For tape playback or to monitor while recording: connect the cable from the tape recorder left channel output to the Left TAPE 1 INPUT. Connect the cable from the tape recorder right channel output to the right TAPE 1 INPUT. Connect a second recorder in the same manner to the VCR 2/TAPE 2 INPUT.

## 7. PROCESSOR

Use the EXTERNAL PROCESSOR jacks to add a noise reduction or any audio signal processing device. Be sure to match the left to left and right to right channels when connecting external processors.

The EXTERNAL PROCESSOR FROM jacks have switching contacts which allow the signal to pass through them when nothing is plugged into the jacks. When an external processor is used, the program is routed to the external processor from the EXTERNAL PROCESSOR TO jack and back by the EXTERNAL PROCESSOR FROM jack.

**WHEN AN EXTERNAL PROCESSOR IS USED, THE PROCESSOR MUST BE TURNED ON FOR THE PROGRAM TO BE HEARD THROUGH THE SYSTEM.**

## 8. OUTPUTS TAPE 1, TAPE 2

To record, connect a cable from the Left OUTPUTS TAPE 1 to the left high-level input of the tape recorder. Connect a cable from the Right OUTPUTS TAPE 1 to the right input of the tape recorder. Connect a second recorder in the same manner to the OUTPUTS TAPE 2.

## 9. OUTPUTS PREAMP /POWER AMP IN

Jacks are provided on the rear panel for connecting a McIntosh Environmental Equalizer, or signal processing equipment. Connect the left and right shielded cables from the equalizer outputs to the Left and Right POWER AMP IN jacks. Then connect shielded cables between the Left and Right OUTPUTS PREAMP jacks to the equalizer inputs.

The input jacks are automatic switching jacks that disconnect the preamplifier's output signal from the power amplifier's input and connects the environmental equalizer signal processor's output to the power amplifier's input.

## 10. REMOTE CONTROL

The REMOTE CONTROL connector is designed for use with the McIntosh multiple area infrared remote control systems. With these systems, you can from a hand-held remote unit, turn on the system, select from the programmed stations, or scan the entire broadcast band on either AM or FM and raise or lower volume in the local area without affecting any other area. With a McIntosh Compact Disc player in the system you can turn the player on or off, play a disc, move to the next track, back up a track, raise or lower the volume in the local area, mute the local program without affecting any other area or you can stop the playing of the disc. In addition, a third program source can be selected.

## 11. FM ANTENNA

The antenna input impedance is 75 ohms. The input connector is a "Type F" which mates with cable company feed lines and coaxial cable. Interference rejection and low signal loss are among the benefits of coaxial cable.

Any one of four different FM antenna systems can be used with your MAC 4275. 1) an outdoor FM antenna, 2) an all channel (UHF-VHF-FM) antenna, 3) a cable input from your local cable company, or 4) the indoor dipole supplied.

A 75-ohm outdoor antenna designed for FM reception is recommended for optimum performance in all areas. In fringe areas, best results will be obtained with a highly directional FM antenna used with a rotator. Adjust the position of the antenna until the best reception is obtained.

A 75-ohm indoor dipole antenna supplied with your MAC 4275 may be used in urban or in high signal strength areas. The flexibility of the thin wire assembly permits it to be placed under a rug, tacked behind the stereo, or placed in any other convenient location. In some cases, it may be necessary to position the antenna for best signal reception. Avoid locating this antenna next to other wires of metal objects. An indoor antenna may not prove effective in houses having metal siding or metal insulation.

Although a 75-ohm coaxial cable provides the best noise and multipath reception, many antennas use 300-ohm twin lead. In this case, use a matching transformer (balun) to convert a 300-ohm antenna to the 75-ohm input impedance of the tuner.

---

# 6 HOW TO CONNECT

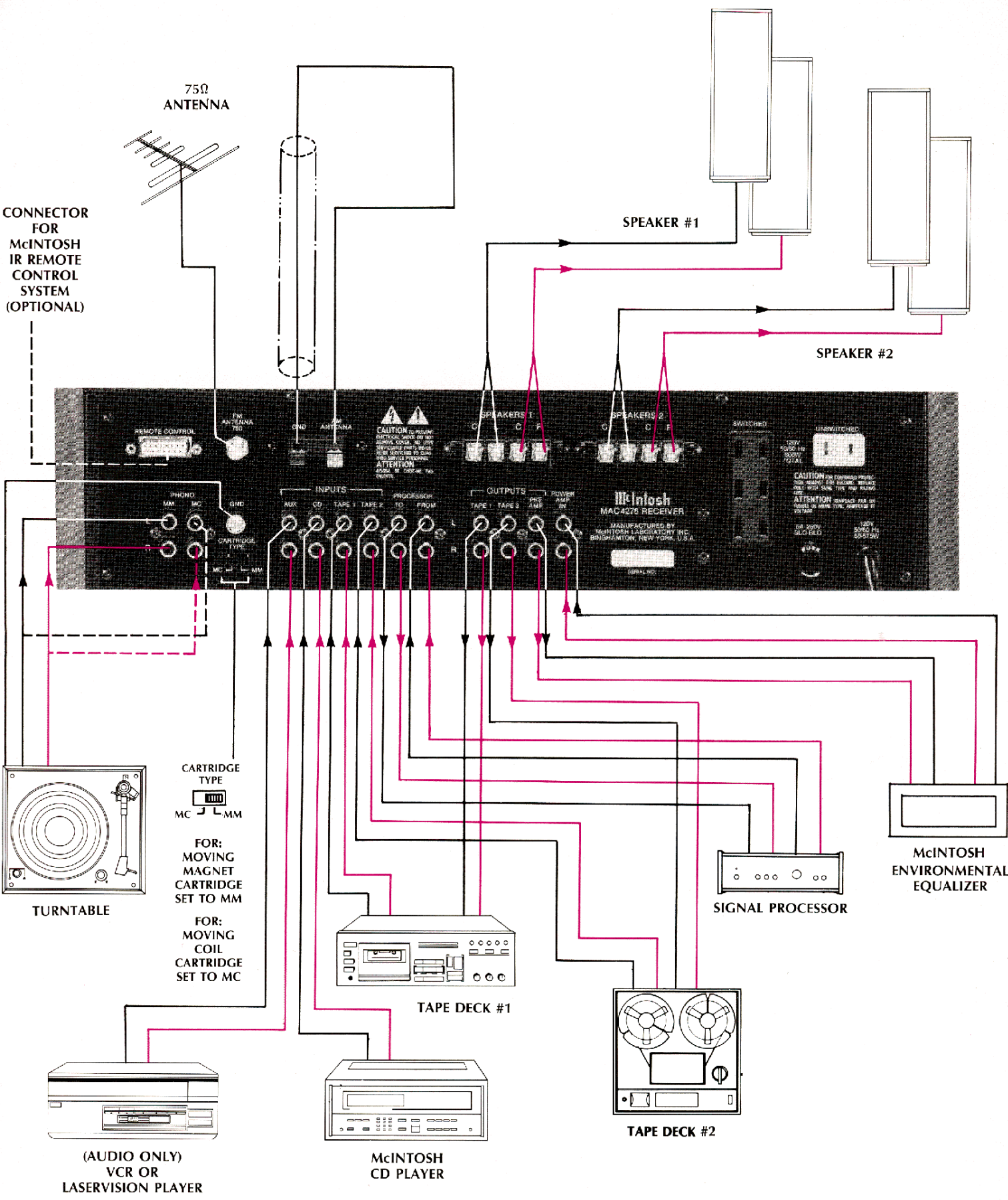

# HOW TO CONNECT 7



## 12. AM ANTENNA/GND

The AM antenna input on the MAC 4275 is unusual in that it will accept almost any type of antenna. For example: in a location of moderate signal strength and little interference (few fluorescent lights, motors, TV sets, etc.), a piece of wire as short as 6 feet will give good performance. In a rural area, an outdoor longwire might be desirable. For the best overall performance use a shielded loop antenna.

A shielded loop antenna is made from a length of single conductor shielded wire; microphone cable, coaxial cable, etc., arranged in a single loop.

To prepare an antenna from the shielded cable, strip  $\frac{3}{4}$  of an inch of outer insulation from each of the cable ends. From one end, completely remove the exposed  $\frac{3}{4}$ " of mesh shielding. Then remove  $\frac{3}{8}$  of an inch of insulation from the center conductor.



Insert the exposed center conductor into the AM ANT push connector. Make sure the cut off mesh shield does not come in contact with anything. On the other end, leave the mesh shield intact and strip  $\frac{3}{8}$  of an inch of insulation from the center conductor. On this end only, twist the exposed center conductor and mesh shield together.



Insert the twisted shield and center conductor into the ground (GND) push connector.

For best reception, orient the loop vertically. It may be attached around the frame of a window behind a curtain, on the back of the equipment cabinet, or in some similar way. Signal strength is proportional to the size of the loop; the larger the loop, the greater the received signal.

## 13. AC POWER

A polarized AC plug is used on the MAC 4275. Plug it into a 120 volt 60 Hz wall outlet. The plug blades must be fully inserted in the outlet to prevent shock from exposed blades.

**CAUTION: TO PREVENT ELECTRICAL SHOCK DO NOT USE THE (POLARIZED) PLUG ON THIS UNIT WITH AN EXTENSION CORD, RECEPTACLE OR OTHER OUTLET UNLESS THE BLADES CAN BE FULLY INSERTED TO PREVENT BLADE EXPOSURE.**

Two types of AC power outlets are provided on the back panel on the MAC 4275: 3 black, and one white.

The black outlets are switched on or off when the MAC 4275 is turned on or off. These are intended for CD players equalizers or other accessories, whose total power requirement is 600 watts or less.

The white outlet is on at all times. For example, a VCR (video cassette recorder) can be plugged into this outlet for recording a TV program when the receiver is not turned on. Neither the white outlet nor the black outlets are fused.

## CONNECT ADDITIONAL POWER AMPLIFIERS

External power amplifiers may be fed from the MAC 4275 in two ways:

1. Connect a shielded cable from the Left and Right OUTPUTS PREAMP jacks to the Left and Right input of the power amplifier. The OUTPUTS PREAMP jacks are affected by all the front panel controls. Both the MAC 4275 amplifier and the additional amplifier will be fed from the preamplifier.

2. The OUTPUTS TAPE 1 or TAPE 2 jacks may be used to drive an external amplifier which has its own controls. The source of sound is selected by the RECORD selector switch. The output of these jacks is not affected by the VOLUME, EQUALIZER, BALANCE and LOUDNESS controls on the receiver. A suggested use would be to feed an amplifier in a remote location where volume and tone requirements need to be controlled at the remote amplifier. In this configuration, the connections can not be used for a tape recorder.

---

# 8 HOW TO CONNECT



The back cover folds out to show photographs of the front and rear panels of the MAC 4275. Fold it out to assist you in identifying the controls and pushbuttons. The letters on the photographs refer to the paragraphs that follow.

To gain maximum results from your MAC 4275 please familiarize yourself with the controls and indicators and their purposes. The upper left area of the front panel displays the station frequency, center channel tuning, station signal strength, the power output and Power Guard. To the right of the display area are the 5 programmed station select pushbuttons, the ENTER pushbutton, the AM and FM pushbuttons and the SCAN pushbuttons. The manual tuning knob is to the right of these pushbuttons.

#### A. POWER OUTPUT INDICATORS

The amplifier POWER output indicators are to the left of the station display area. There are two vertical columns of red Light Emitting Diode (LED) bar indicators; one for each channel.

The left column represents the output from the left channel and the right column the right. Each row is independent of the other. As power output increases, more bar indicators are turned on. The power indicators provide constant and instant information on the amount of power being fed to your speakers.

When the POWER GUARD\* circuit is activated, the top bar on each column will light.

#### B. POWER GUARD\* (PG)

POWER GUARD\* assures that the amplifier can not be overdriven so amplifier output clipping can not affect the sound reproduction. Clipping occurs when the amplifier is asked to produce more power output than it can deliver with low distortion. Amplifiers are capable of delivering large quantities of heating power when they are driven to clipping and the output can have more than 40% harmonic distortion. The extra energy content of the clipped signal will damage most speakers. A McIntosh advancement helps to protect your speaker from this kind of damage. The POWER GUARD\* circuit compares the wave shape of the input signal with the output signal. If the wave shape difference between the two signals exceeds 0.5% the POWER GUARD\* circuit operates.

#### C. STATION FREQUENCY DISPLAY

The ½" high LED digital display of station frequen-

cy on both FM and AM provides a high degree of accuracy and is easy to read. In many receivers, only the odd numbered frequencies are tunable and displayed. The MAC 4275 displays all FM frequencies 88.0 to 108.0 MHz in 100 kHz increments, and all AM frequencies.

#### D. SIGNAL INDICATOR

The SIGNAL strength indicator is at the right of the station display area. The vertical row of five LED bar indicators, shows the relative strength of an FM or AM station being received. The greater the number of bars illuminated, the greater the received station's signal strength.

#### E. TUNING INDICATOR

Two LED's ►◄ two horizontal arrows located below the SIGNAL indicator, make up the FM TUNING indicator. A station is precisely center channel tuned when a station is heard and neither arrow is illuminated.

One of the arrows will light as a station is approached to indicate tuning above or below the center frequency of the station.

The McIntosh circuit locks to the center of the broadcast stations' frequency preventing any detuning or drift. The locking action makes tuning easy and allows the best reception with lowest background noise, lowest distortion, and highest FM stereo channel separation.

#### F. FM MPX

FM stereo broadcasts will cause the FM MPX bar indicator to illuminate. It is located above the signal and tuning indicators. When the MONO pushbutton is in the indicator does not light.

#### G. PRESET STATION SELECTING PUSHBUTTONS

A momentary press on one of the pushbuttons marked 1 thru 5 will recall from the electronic memory the preset FM or AM station.

#### H. ENTER

The ENTER pushbutton followed by any one of the five momentary pushbuttons is used to insert into the electronic memory the tuned FM or AM station. Five FM and five AM stations can be preset.

To enter a station in the memory, tune to the desired station with either the manual tuning knob or SCAN tuning. Then press the ENTER pushbutton and, within 5 seconds, press pushbutton 1. The station tuned will be recorded in the electronic memory for instantaneous recall when pushbutton 1 is pressed.

\*U.S. Patent #408573

Repeat for each of the pushbuttons.

The preset memory circuits are maintained by a power supply which can retain the memory as long as the receiver is plugged into the AC line. Should the receiver be unplugged, a special circuit will maintain the memory for approximately one week.

#### I. AM

The AM pushbutton switches to the AM circuits of the tuner. The station display area will show the AM station frequency in kilohertz.

#### J. FM

The FM pushbutton switches to the FM circuits of the tuner. The station display area will show the FM station frequency in megahertz.

#### K. SCAN

Use the SCAN pushbutton to automatically tune to the next station either up or down the selected broadcast band. The arrow beside the pushbutton indicates the direction of the scan. In the SCAN mode, between-station noise and distant or weak stations are automatically muted.

#### L. MANUAL TUNING

To tune any station that has not been entered in the pushbutton memory rotate the tuning knob. The changes in frequency will be displayed as the knob is rotated.

#### M. POWER

The red pushbutton turns the AC power on or off. When the power is on, the station frequency, the tuning, and the signal strength indicators illuminate. At turn on, the tuner returns to the last tuned station which has been automatically retained in the tuner's memory.

#### N. HEADPHONE JACK

Plug headphones into the front panel HEADPHONE jack. Adjust the front panel VOLUME control for comfortable headphone listening.

Signal to the headphone jacks is not affected by the SPEAKERS 1 and 2 switches. The circuits feeding the HEADPHONE jack have been designed to feed low impedance dynamic headphones.

#### O. SPEAKERS 1 and 2

When each of these pushbuttons is pressed the output of the receiver is fed to the pair of loudspeakers connected to the corresponding rear panel SPEAKERS connectors. SPEAKERS 1 and 2 may be selected singly or both at once.

#### P. EQUALIZER FREQUENCY

Each of three EQUALIZER FREQUENCY controls modifies, upward or downward, the tone balance of a band of frequencies centered on the frequency marked above the control. The flat position of the control has a detent for easy reference. In the detent position on each control the entire equalization circuit for that control is disconnected. Each circuit provides up to 12 dB boost or cut at the specified center frequency.

Use the EQUALIZER FREQUENCY controls to modify the sound and tone balance of program material. Here are some suggestions from which to start:

Problem	Equalizer Correction
Bass too weak	Raise 30
Male vocalist needs reinforcing	Raise 30
Hum on program	Reduce 30
Female vocalist reinforcing	Raise 750
Violins, trumpets dull	Raise 750
Drum "brushes" not audible	Raise 10 K
Hiss and/or noise on program	Reduce 10 K

#### Q. SPEAKER COMPENSATION

When pressed in, the bass frequencies are augmented a quarter of an octave each side of 70 Hz. The boost can complement the bass response in this frequency range.

#### R. MONO

The MONO pushbutton switches the audio output of the receiver from stereo mode to MONO. When the INPUT SELECTOR is in the FM position and tuned to a stereo broadcast the FM MPX light will remain on regardless of the position of the MONO pushbutton. The program, with the MONO pushbutton in, will be heard as mono. The TAPE OUT jacks are not affected by the MONO pushbuttons.

#### S. RECORD and LISTEN

Each of these controls selects a source independently and without any interference with the other. The source selected by the LISTEN switch is connected to the loudspeakers and HEADPHONE jack. The source selected by the RECORD switch is connected to the TAPE 1 and 2 OUTPUTS. This arrangement permits tape recording one program while listening to another. To monitor the tape rotate the LISTEN switch to either of the tape positions.

---

## 10 FRONT PANEL



## T. LOUDNESS

The LOUDNESS pushbutton, when pressed in, provides frequency contoured response to compensate for the hearing characteristics of the human ear at lower listening levels. At low listening levels, bass frequencies are increased to provide contoured response modeled after the family of "equal loudness" curves identified by Fletcher and Munson.



---

# FRONT PANEL 11



## PERFORMANCE LIMITS

Performance limits are maximum deviation from perfection permitted for a McIntosh instrument. We promise you that when you purchase a new MAC 4275 from a McIntosh franchised dealer, it will be capable of or can be made capable of performance at or exceeding these limits or you can return the unit and get your money back. McIntosh is the only manufacturer that makes this statement.

## AMPLIFIER SECTION

### STEREO POWER OUTPUT

75 watts into 8 ohm loads or 100 watts into 4 ohm loads is the minimum sine wave continuous average power output per channel, from 20 to 20,000 Hz, with both channels operating.

### POWER BANDWIDTH

20 to 20,000 Hz

### TOTAL HARMONIC DISTORTION

0.03% maximum at any power level from 250 milliwatts to rated power per channel, 20 to 20,000 Hz, both channels operating.

### INTERMODULATION DISTORTION

0.03% maximum at any power level from 250 milliwatts to rated power per channel, for any combination of frequencies from 20 to 20,000 Hz, with both channels operating.

### FREQUENCY RESPONSE

+0, -0.5 dB from 20 to 20,000 Hz at rated power

### INPUT SENSITIVITY

Phono (MC)—0.12 mV

Phono(MM)—2.5 mV produces rated output

Tape, Aux—250 mV produces rated output

Power Amp—1.5 V produces rated output

### SIGNAL TO NOISE RATIO, A-WEIGHTED

Power Amp—100 dB below rated output

Tape, Aux—95 dB below rated output

Phono—90 dB with 10 mV input

### MAXIMUM INPUT SIGNAL

Phono (MC)—4.1 mV

Phono (MM)—80 mV

High level—8 V

### INPUT IMPEDENCE

Phono (MC)—100 ohms

Phono (MM)—47k ohms

Tape, Aux—20k ohms

Power Amp—18k ohm

## DAMPING FACTOR

Greater than 50 at 8 ohms

## TAPE OUTPUT

Phono—250 mV with rated input

Tape—250 mV with rated input

Tuner—1.0 V at 100% modulation (FM)

## PROGRAM EQUALIZER

± 12 dB at 30, 750, and 10 kHz

## FM SECTION

### USABLE SENSITIVITY

11.25 dBf which is 1.0 $\mu$ V across 75 ohms

### 50 dB QUIETING SENSITIVITY

Mono—15.2 dBf which is 1.6 $\mu$ V across 75 ohms

Stereo—27 dBf which is 6 $\mu$ V across 75 ohms

### SIGNAL TO NOISE RATIO

Mono—80 dB

Stereo—75 dB

### FREQUENCY RESPONSE

Mono— +0.5, -0.5 dB from 20 to 15 kHz

Stereo— +0.5, -0.5 dB from 20 to 15 kHz

### HARMONIC DISTORTION

Mono—0.15% at 100 Hz

0.1% at 1k

0.1% at 10k

Stereo—0.1% at 100 Hz

0.1% at 1k

0.25% at 10k

### INTERMODULATION DISTORTION

Mono—0.1%

Stereo—0.2%

### CAPTURE RATIO

1.5 dB

### ALTERNATE CHANNEL SELECTIVITY

60 dB

### SPURIOUS RESPONSE

95 dB

### IMAGE RESPONSE

90 dB

### AM SUPPRESSION

60 dB

### STEREO SEPARATION

35 dB at 100 Hz

45 dB at 1k

40 dB at 10k

### SCA REJECTION

65 dB

---

# 12 PERFORMANCE LIMITS

## AM SECTION

### SENSITIVITY

25  $\mu$ V (External Antenna)

### SIGNAL TO NOISE RATIO

50 dB at 30% modulation

60 dB at 100% modulation

### HARMONIC DISTORTION

1.0% maximum at 50% modulation (0.2% typical)

### FREQUENCY RESPONSE

+0, -6 dB 30 Hz to 3.5 KHz

### ADJACENT CHANNEL SELECTIVITY

50 dB minimum IHF

### IMAGE REJECTION

50 dB minimum

### IF REJECTION

55 dB minimum

## GENERAL INFORMATION

### SEMICONDUCTOR COMPLEMENT

78 Silicon Diodes

13 Tuning Devices

24 Light Emitting Diodes

4 Seven Segment LED Displays

59 Bipolar Transistors

3 Field Effect Transistors

38 Integrated Circuits

### POWER REQUIREMENTS

120 volts, 50/60 Hz, 60 to 575 watts

## MECHANICAL INFORMATION

### SIZE

Width: 18¼ inches (46.4 cm)

Height: 5¼ inches (13.3 cm)

Depth: 15½ inches (39.4 cm)

### FINISH

Front panel is brushed black anodize with gold anodize trim. Side panels are machined solid walnut with satin lacquer finish.

### WEIGHT

25 pounds (11.3 kg) net, 32 pounds (14.5 kg) in shipping carton.

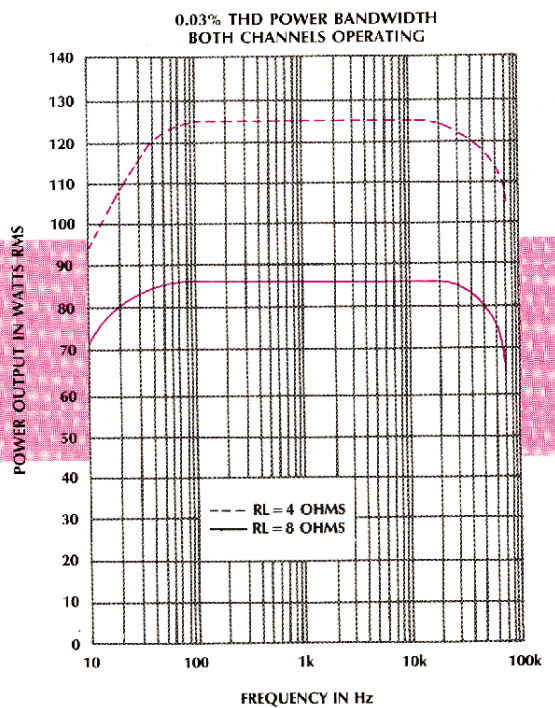
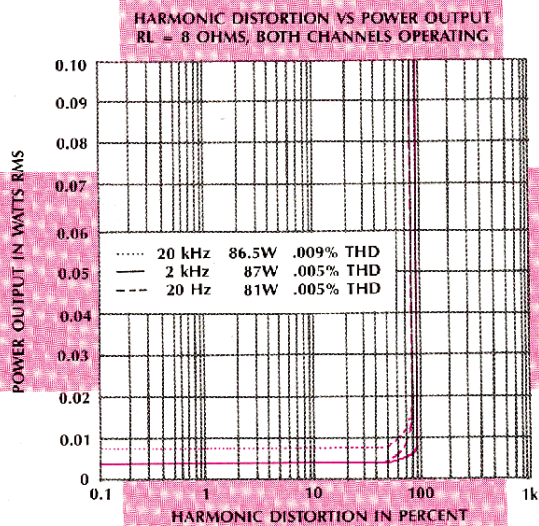
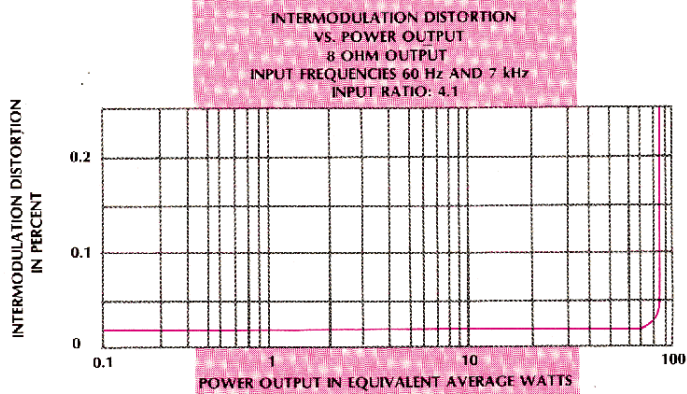
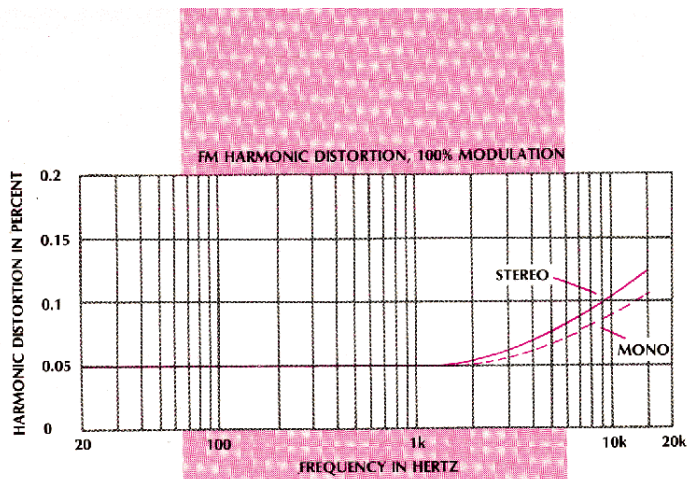

# 14 PERFORMANCE CHARTS



EQUALIZER CONTROLS

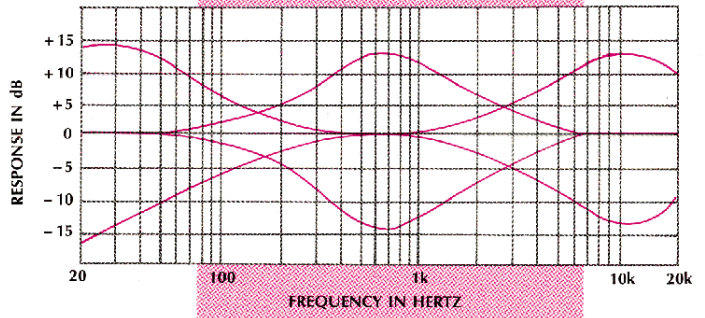

OUTPUT SIGNAL WAVEFORM SHOWING ACTION OF POWER GUARD TO ELIMINATE OUTPUT SIGNAL CLIPPING. POWER AMPLIFIER INPUT IS OVERDRIVEN BY 20 dB FOR BOTH OSCILLOGRAM TRACES.

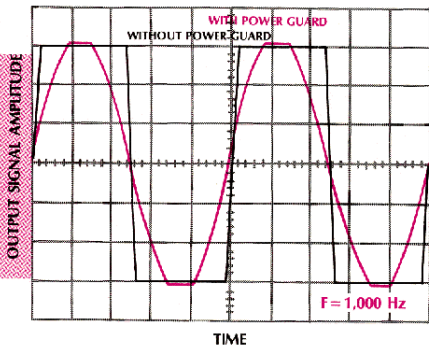

FM PERFORMANCE, 98 MHz 1kHz MODULATION

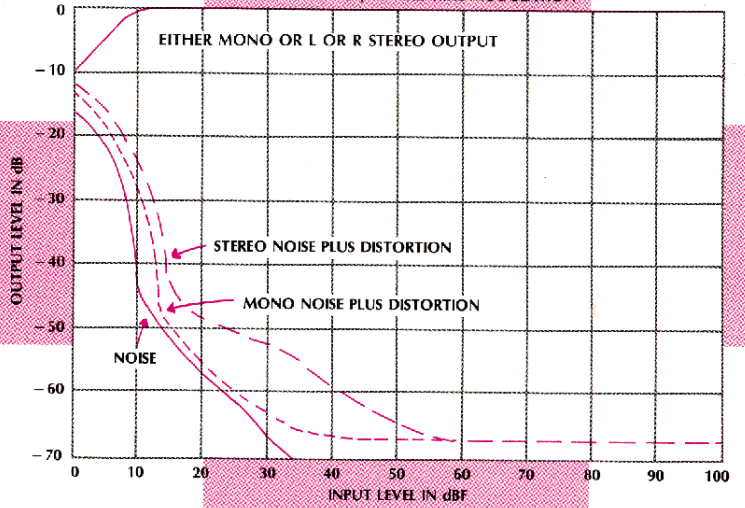

FM FREQUENCY RESPONSE AND STEREO SEPARATION

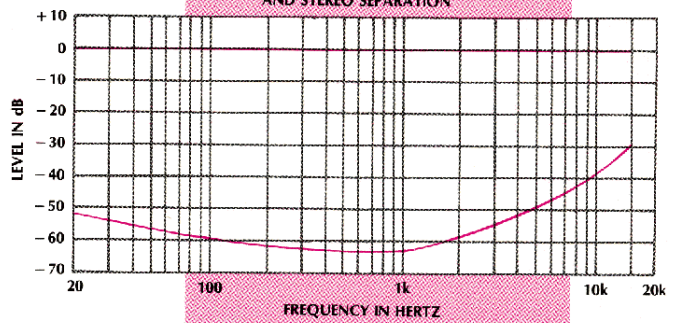



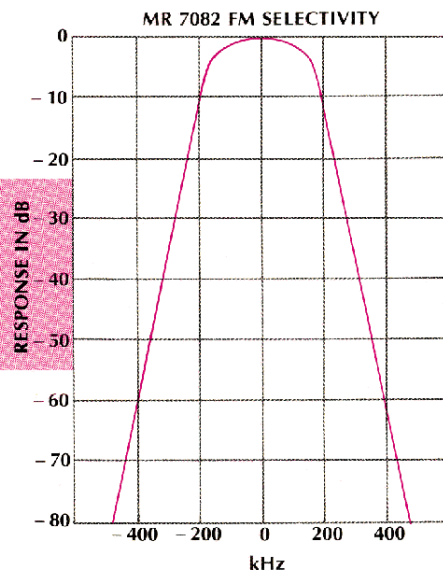
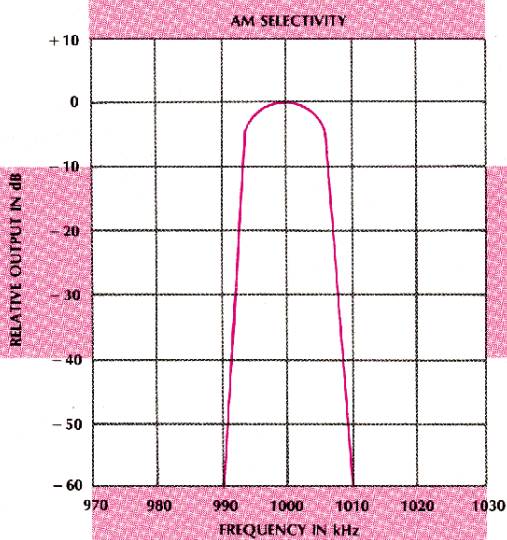
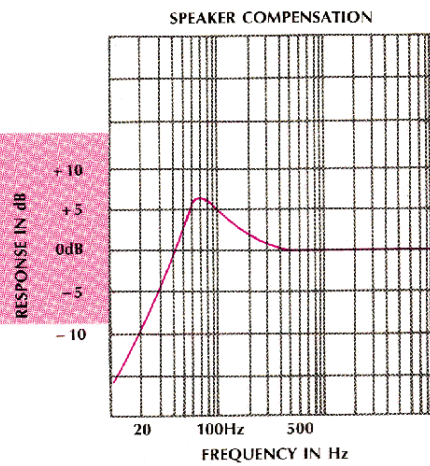
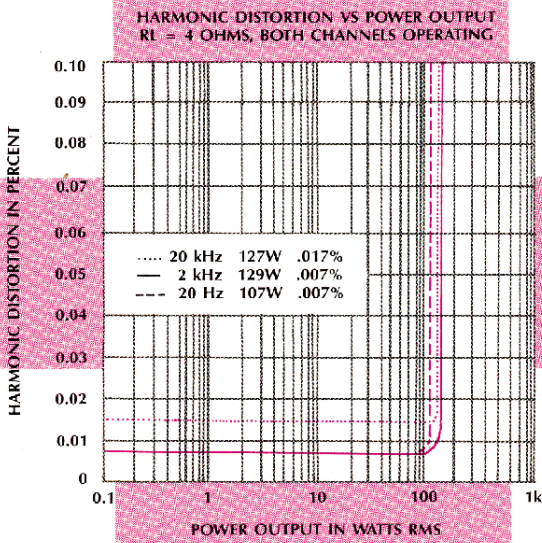
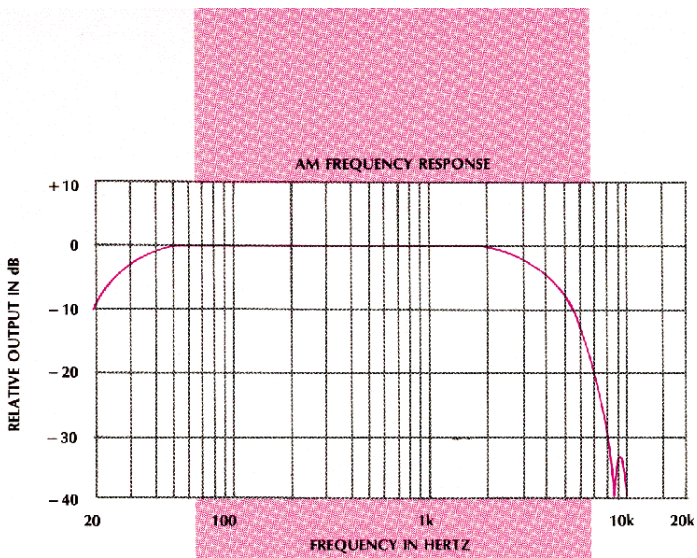

# 16 PERFORMANCE CHARTS



## TUNING SYSTEM

Three modes of tuning are provided in the MAC 4275: MANUAL, SCAN, and PRESET.

In the MANUAL mode two photo electric detectors sense the direction and degree that the tuning knob is rotated and move the tuner frequency accordingly. The tuning mechanism is comprised of small metal vanes whose rotation interrupts light beams. This system provides smoothness and ease of tuning. Friction is almost non-existent and flywheel action is extremely smooth.

When SCAN is pressed, a ramped tuning voltage is generated, increasing in voltage to SCAN up, decaying to SCAN down. The ramp continues until the zero crossing of the detector S curve is sensed at the input of the controller. It then stops and maintains that voltage with any necessary correction added.

Once a station has been tuned by either the MANUAL or SCAN mode it may be entered into any of the five memory locations: press ENTER, then within 5 seconds, any STATION button, 1 through 5. The station is then stored in the tuning controller's memory. A small power supply maintains the memory for as long as the receiver is plugged in. If the receiver is unplugged or if any power interruption occurs a storage cell in the receiver will maintain the memory for more than one week.

A momentary press of a preset STATION pushbutton will instantaneously recall the station from memory. Each time a pushbutton is pressed, a mute pulse suppresses any noise that might occur during the tuning process. During the scan mode, an output from the controller lowers the tuner sensitivity to prevent weak, noisy stations from being heard. To listen to weak stations, tune manually.

## FM TUNER

A type F connector is provided on the rear panel to connect a 75 ohm antenna or cable system. An RF tuner of exceptional performance follows the antenna matching circuit. The tuner uses a DMOSFET RF amplifier, mixer and 5 RF circuits that are tuned by matched varactor diodes. These precision components give high spurious rejection and super sensitivity. The circuit uses high tuning voltage to eliminate RF intermodulation distortion ordinarily caused by diode nonlinearities.

The FM IF section uses 2 transistors, 3 linear phase piezoelectric filters, and 2 integrated circuits. These elements combine to provide over 120 dB of gain

with selectivity greater than 60 dB. Limiting, muting, signal strength drive, and FM detection are all functions of the last integrated circuit.

A phase locked loop (PLL) stereo decoder integrated circuit is the core of the multiplex section. It has high signal to noise ratio, low distortion, high channel separation, and high SCA rejection. The PLL MPX IC eliminates inductors to minimize drift, provides integral lamp driving capability for stereo indication, and has transient free mono/stereo switching.

Following the PLL MPX decoder an LC tuned notch filter is used to prevent tape recorder bias interference. The LC filter is driven from the MPX output amplifier and is terminated by an operational amplifier to provide the necessary filter input and output impedances for proper phase response.

## AM TUNER

The AM antenna input on the MAC 4275 is unusual in that it will accept almost any type of antenna. In a location of moderate signal strength and little interference (few fluorescent lights, motors, TV sets, etc.), a piece of wire 6 feet long will give good performance. In a rural area an outdoor long-wire might be desirable. However, the best overall performance can be obtained by using a shielded loop antenna. The larger the loop the stronger the signal. The shielded loop is a bi-directional antenna. Its maximum signal pickup occurs when the station lies in the same plane as the loop. Minimum signal is perpendicular to the plane of the loop. This characteristic can be used to advantage by arranging the loop so that an unwanted signal, noise or interfering station, is in the pickup null.

The first element in the AM input section is a bandpass filter. It passes the band of AM station frequency and rejects all others. The next element is a J FET-Transistor cascode amplifier. This amplifier, with its J FET input stage, provides excellent sensitivity and spurious response rejection. It also has a delayed AGC system that does not degrade the tuner overload performance.

The following two tuned circuits, a second RF amplifier and a double balanced mixer, provide excellent image and IF rejection.

The mixer's 450 kHz output feeds a matching transformer which couples a wide band linear phase piezoelectric 4 element lattice filter. Then follows the IF amplifier, another transformer, and finally the AM

detector, filter and muting circuits

#### **AUDIO INPUT SWITCHING**

The MAC 4275 has two input selector switches; RECORD which selects the program source that feeds the tape output and LISTEN that selects the program source that feeds the amplifier and speakers.

#### **PHONO AMPLIFIER**

The moving magnet (MM) phono amplifier uses a high technology integrated circuit operational amplifier. Its differential input stage has been optimized for low noise and low distortion performance. The integrated circuit's open loop gain is 100,000. With high open loop gain a large amount of negative feedback can be used around the phono amplifier to further reduce noise and distortion. The feedback network provides, in addition, RIAA frequency compensation. Components in the network are 1% metal film resistors and 5% poly film capacitors.

The phono amplifier has a very wide dynamic range. Input sensitivity is 2.5 millivolts with a gain of 40 dB at 1k. At 1k the phono input circuit will accept 80 millivolts without overload, a voltage far greater than the output of any currently used magnetic phono cartridge. 10 millivolts at the phono input at 1k will produce 1 volt at the tape output. The tape output source impedance is 220 ohms, designed to operate into a load impedance of 5k ohms or greater.

The moving coil (MC) phono amplifier is an additional amplifier stage that precedes the MM amplifier. It uses two bi-polar transistors selected and operated for low base diffusion resistance which is required to hold the noise level to a minimum.

#### **EQUALIZER AMPLIFIER**

The equalizer amplifier also uses high technology integrated circuit operational amplifiers with the output stage optimized for the best transient performance with minimum distortion. Three other operational amplifiers are arranged in a circuit configuration equivalent to a series tuned circuit, one at each of the three center frequencies. Each circuit is activated by the control potentiometer in either the input circuit or feedback circuit of the operational amplifier providing a boost and cut capability of 120 dB for each band of frequencies. When the potentiometer is in the center or detent position the operational amplifier is out of the circuit completely.

#### **POWER AMPLIFIER SECTION**

The MAC 4275 power amplifier requires 1.5 volts RMS to drive it to rated output and its input impedance is 18k ohms. The input stage, a differential amplifier, permits the best use of negative feedback for low noise and low distortion performance. Its outputs are combined in a current mirror to form a single output. This combined signal feeds a linear voltage amplifier which drives two medium power driver transistors. The driver transistors feed the output stage.

The output stage is arranged as a fully complementary, direct coupled, push/pull amplifier. The power transistors used are selected for their high power dissipation capability, wide frequency response, and large safe operating area. All power transistors have limits for the maximum amount of heat they can tolerate. The MAC 4275 uses a highly efficient amplifying circuit which produces relatively little heat for the output power produced. Its oversized heat sink, under normal conditions, keeps the output transistors well below their safe temperature limits. If ventilation is restricted or if amplifier efficiency is destroyed by operating it into a short circuit or a very low impedance extra heat will be produced. Thermal sensors will detect the abnormal heat rise and disconnect the speakers.

All power transistors have limits for the maximum amount of electrical current they can handle, the MAC 4275 output circuit and the power supply have been designed to allow very high current flow into a properly matched load impedance. Should a short circuit or very low value of load impedance be applied to the output of the MAC 4275, destructive currents could be reached if they were not controlled by the SENTRY MONITOR\* circuit. The circuit senses the dynamic operating conditions of the amplifier output stages and controls the current flow, confining it to safe limits. The SENTRY MONITOR\* circuit does not limit the power output available from the amplifier nor does it have any effect on signals passing through the amplifier when operating conditions are normal.

A power amplifier which does not use output transformers to bypass DC (direct current) can destroy loudspeakers should there be a failure within the amplifier. The MAC 4275 has a DC detecting circuit connected to the output of each channel. If DC is present at the output, this circuit reacts in milliseconds to open the speaker relay which discon-

---

## **18 TECHNICAL DESCRIPTION**



nects the speakers. The speakers remain disconnected until the cause of the DC has been corrected. Under normal operating conditions the DC protective circuit has no effect on the operation of the output circuit.

#### **POWER GUARD\*\***

POWER GUARD\*\*, a unique feature of McIntosh amplifiers, assures that each channel of the MAC 4275 will deliver full power free of clipping distortion. Clipping is caused when an amplifier is asked to produce more power output with low distortion than its design characteristics permit. Amplifiers when driven to clipping can deliver large quantities of power that will have more than 40% harmonic distortion causing the sound to be grossly distorted. The extra energy content of the clipped signal will damage most loudspeakers, particularly high frequency speakers. The McIntosh POWER GUARD circuit protects your ears and your speakers from this kind of damage.

The POWER GUARD circuit compares the wave shape of the amplifier input and output signals. Normally there is no disparity between these signals and the comparison produces no output. When the amplifier is driven beyond its maximum power capacity a difference will develop. If the voltage disparity exceeds 0.5% (equivalent to 0.5% total harmonic distortion) the difference will cause the Power Guard bar indicators to light. If there is a further increase in the disparity the difference output will, in a few microseconds, control a fast acting electronic attenuator at the amplifier input. This dynamic attenuator reduces the amplifier gain just enough to hold the amplifier output to its maximum undistorted value regardless of the degree of overdrive to the amplifier. The amplifier must be overdriven by 20 dB before the output distortion exceeds 2%.

The wave form comparison is achieved in an especially compensated operational amplifier integrated circuit. Its output is detected by a full wave bridge that feeds signals to the control circuit for the Power Guard indicators and to the electronic attenuator at the amplifier input. The attenuator is a light emitting diode/light dependent resistor network selected for its low distortion and low time constant characteristics.

#### **TURN ON RELAY**

The MAC 4275 has transient-free turn on/turn off characteristics, time-controlled by a transistor switch

that operates a heavy duty relay which connects the outputs to the speakers. The control to the transistor switch is derived from a long time constant capacitor charging network which energizes the relay approximately one second after the AC power switch is turned on. The same circuit has a short turn-off time constant which causes the relay to drop out before the receiver's main power supply has a chance to discharge.

#### **POWER SUPPLY**

Two high current power supplies, a positive 48 volt and a negative 48 volt DC are used to power the output power amplifier. Two large filter capacitors, 12,000 microfarads each, are used to store the large amounts of energy necessary for good filtering and precise voltage regulation. A stable well regulated power supply is required for extended low frequency response and negligible low frequency distortion.

\*(US Patent #408573), \*\*(US Patent #404873)

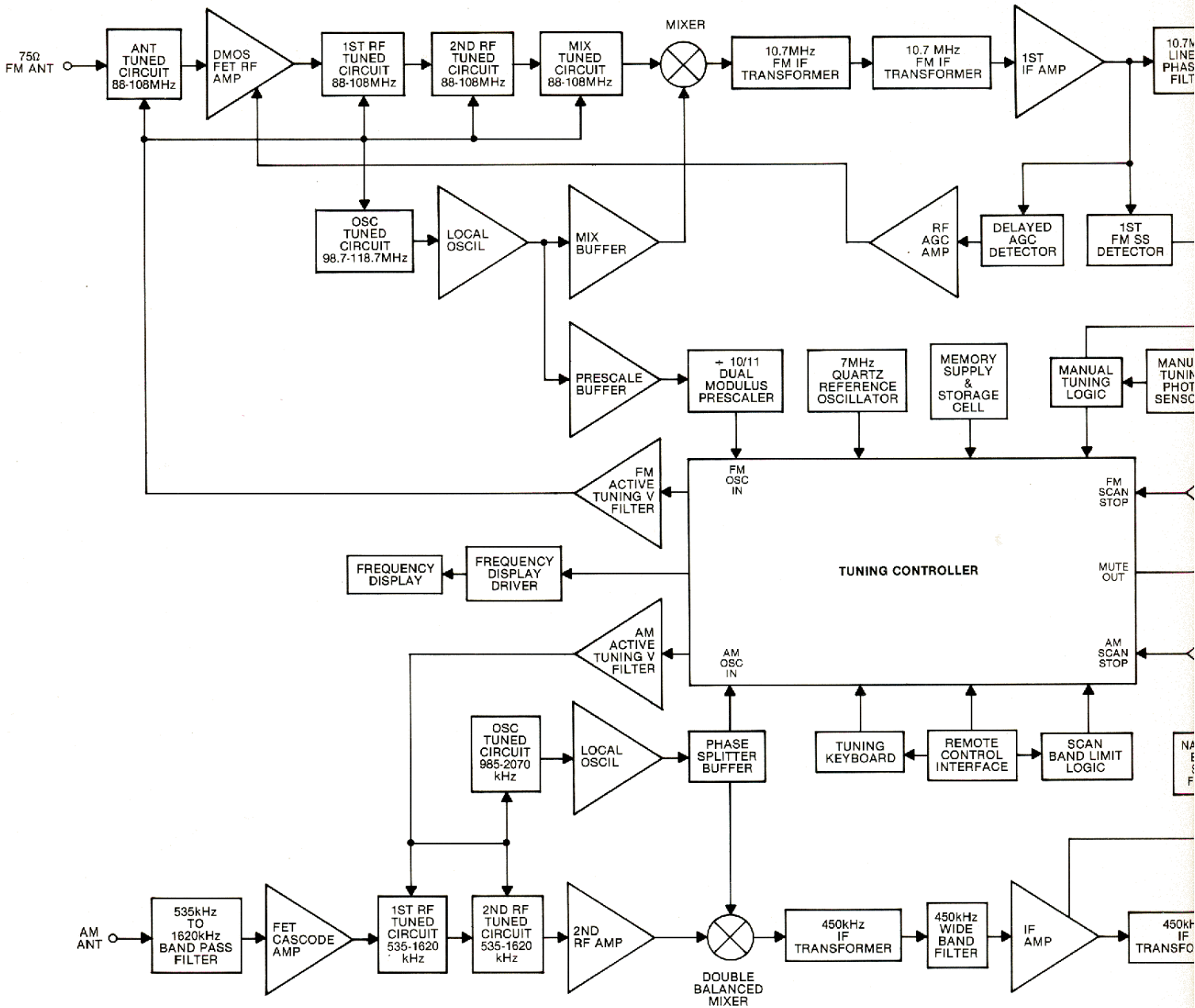

# 20 BLOCK DIAGRAMS



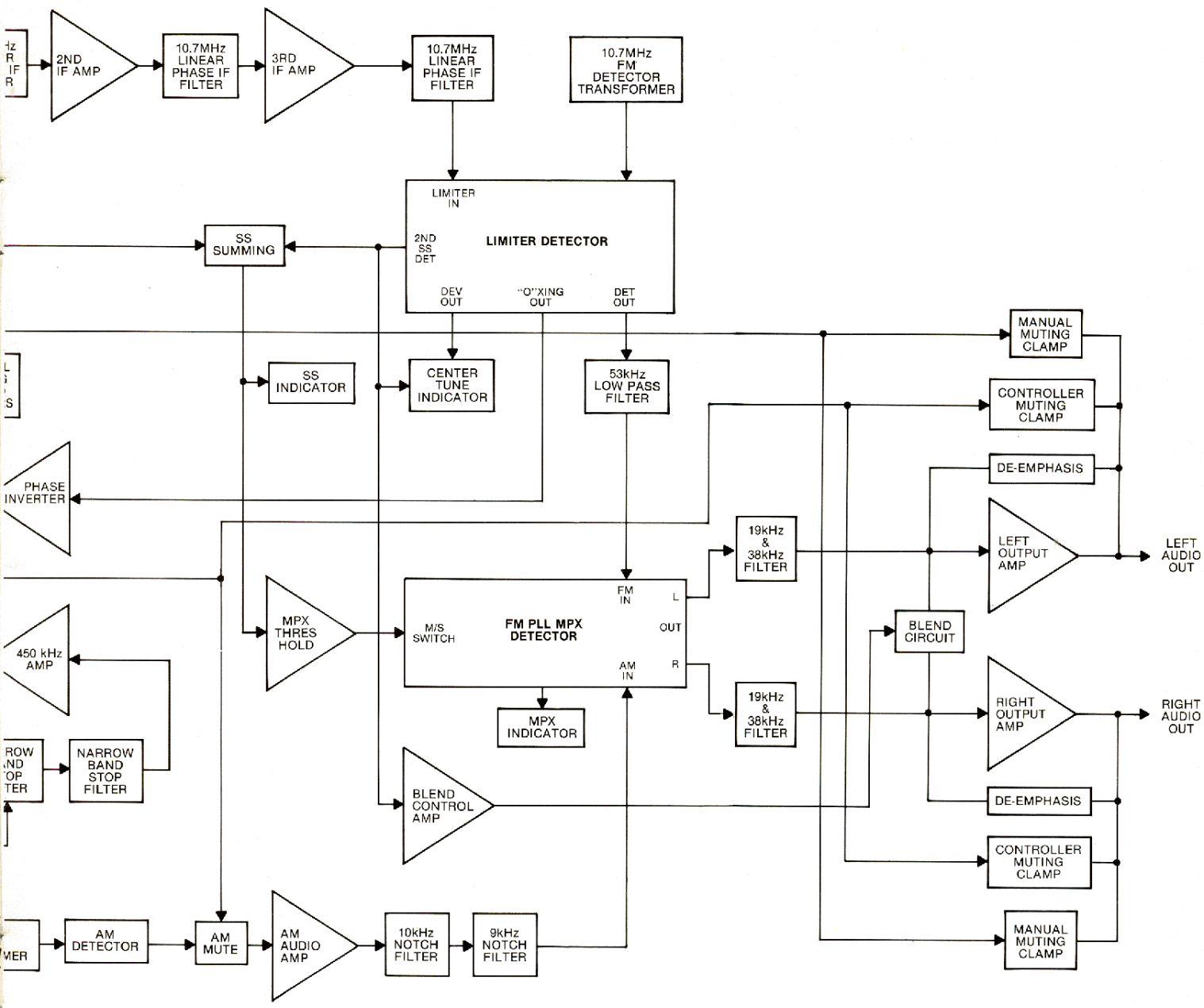

# BLOCK DIAGRAMS 21

ONLY LEFT CHANNEL SHOWN

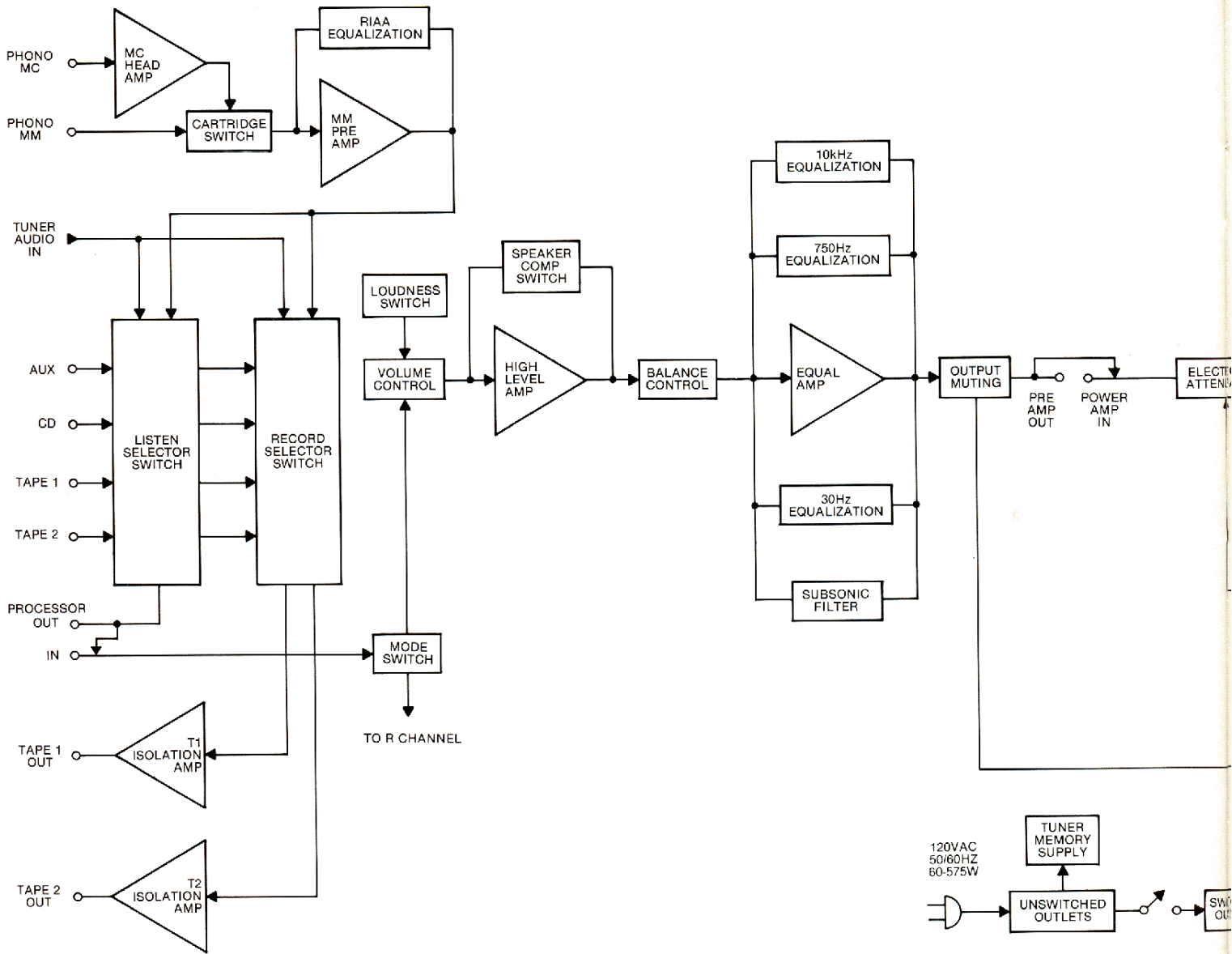

# 22 BLOCK DIAGRAMS



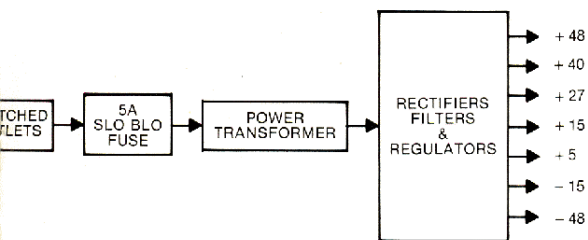
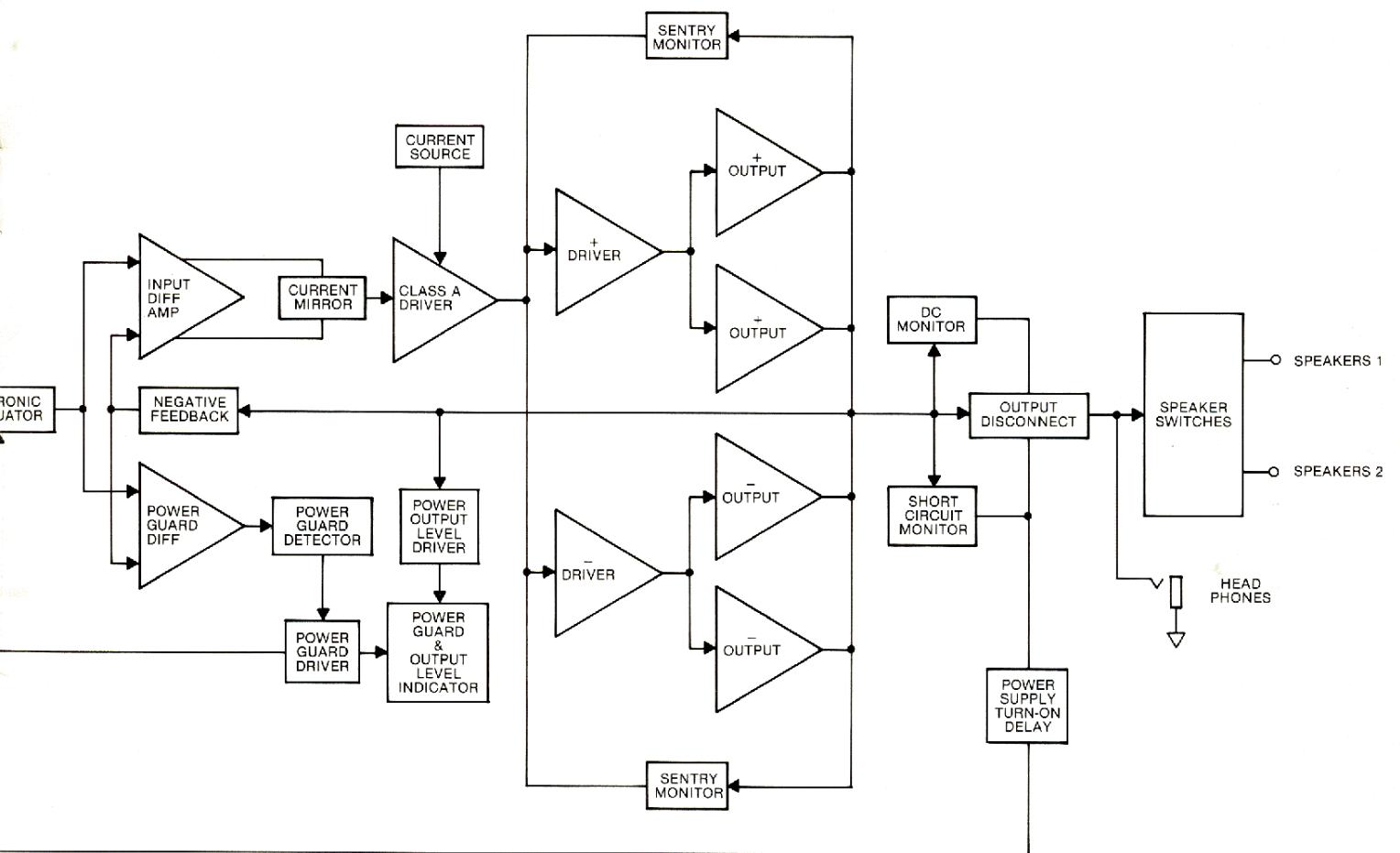



“...Proves out  
 what my grandfather  
 told me, years ago:  
**“BUY THE BEST...  
 QUALITY LASTS”**

McIntosh owner  
 J.C. Mc Orchard Lake, MI

Music reproducing instruments that carry the McIntosh name have always been designed to maintain the McIntosh reputation for best sound, for durability and for long life. McIntosh has, since 1949, lead the industry in technological advancement. McIntosh has always earned the foremost reputation for quality performance, McIntosh has provided user oriented facilities and appearance and McIntosh design always provides ease of maintenance or repair. Regardless of the McIntosh combination you choose you are always assured you have chosen the best, with the latest technology that leads to superior sound reproduction... technology whose integrity has been proven by time.

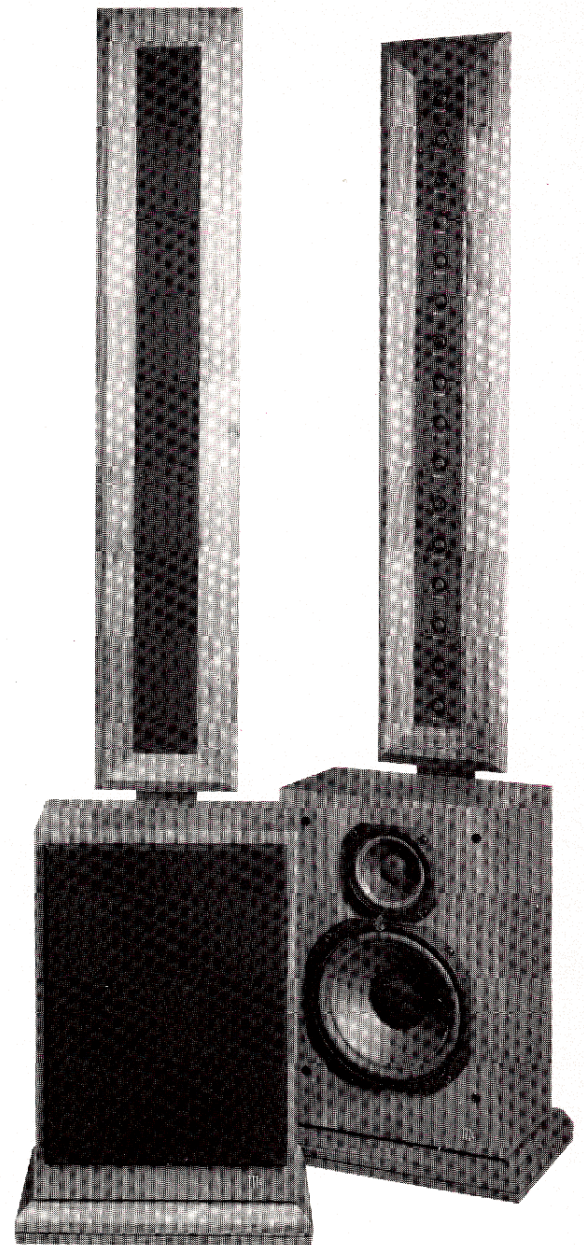

**XRT 18**  
 Isoplanar Loudspeaker System  
 with optional base stand

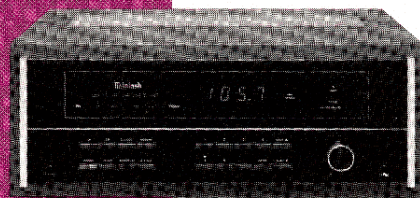

**MR 7082**  
 AM/FM Tuner

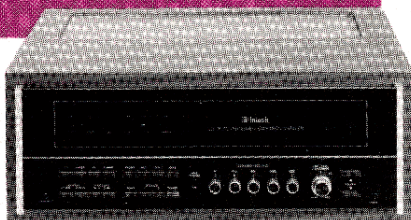

**C 31V**  
 Home Entertainment Control Center

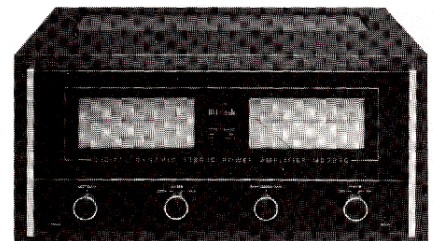

**MC 7270**  
 Power Amplifier

Handcrafted with pride in the United States by dedicated, highly trained craftspeople



# THE LOCATION OF CONTROLS AND PUSHBUTTONS

The numbers and letters correspond to the paragraphs on pages 5 thru 11.

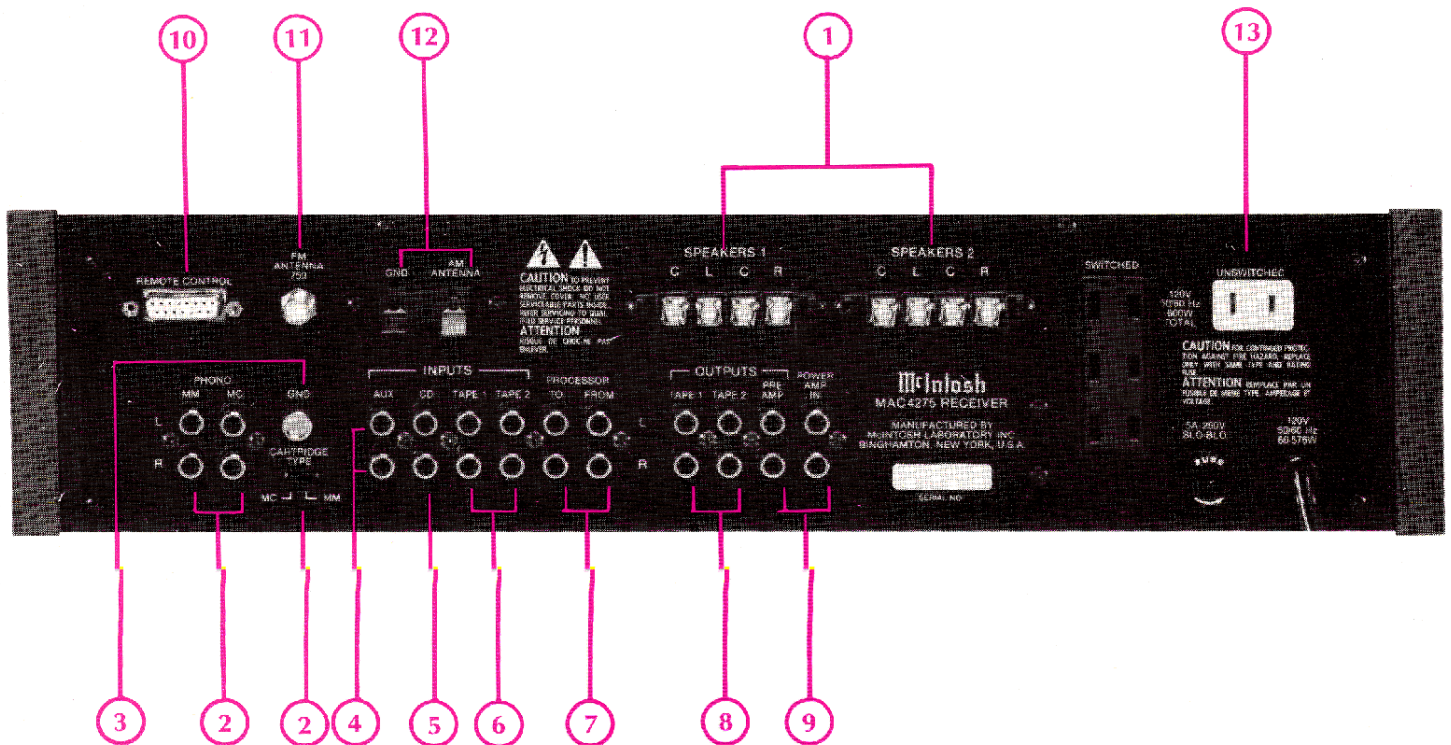
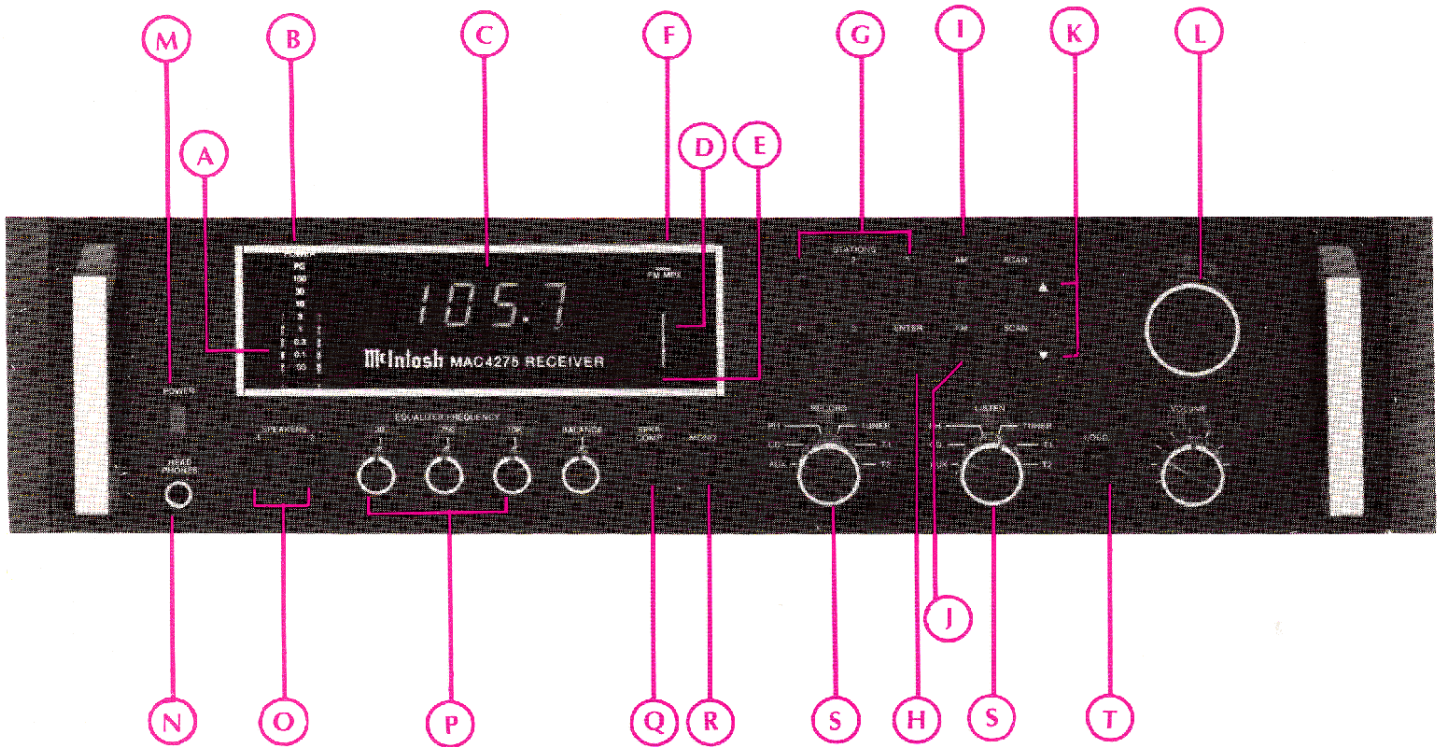



**McIntosh<sup>®</sup>**

**McINTOSH LABORATORY INC.**

**2 CHAMBERS ST., BINGHAMTON, NY 13903-2699**

The continuous improvement of its products is the policy of McIntosh  
Laboratory Incorporated who reserve the right  
to improve design without notice.

039621